

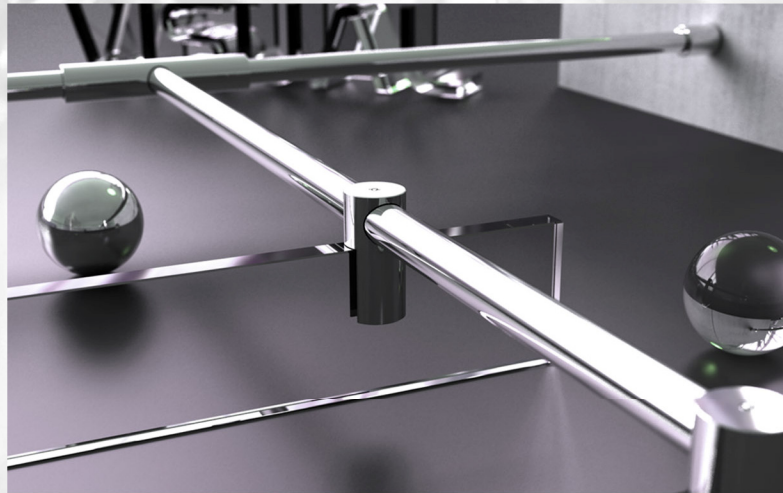

Visual F

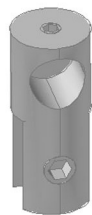

Serie Visual F, conceptualmente basada en la utilización y combinación de paneles fijos. Sistema muy vérsatil de líneas muy puras y con una gran capacidad de combinación entre ellos. Todo el herraje se fabrica en inoxidable.



F001

MATERIAL: Inoxidable AISI 304

ACABADO: Brillo

Soporte vidrio.



F002

MATERIAL: Inoxidable AISI 304

ACABADO: Brillo

Soporte pared.

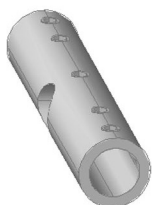

F003

MATERIAL: Inoxidable AISI 304

ACABADO: Brillo

Soporte intersección.

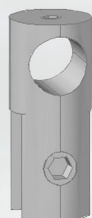

F004

MATERIAL: Inoxidable AISI 304

ACABADO: Brillo

Soporte vidrio intersección.

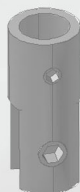

F005

MATERIAL: Inoxidable AISI 304

ACABADO: Brillo

Soporte vidrio techo.



F006

MATERIAL: Inoxidable AISI 304

ACABADO: Brillo

Soporte vidrio 45° izquierdo.

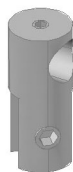

F007

MATERIAL: Inoxidable AISI 304

ACABADO: Brillo

Soporte vidrio 45° derecho.



F008

MATERIAL: Inoxidable AISI 304

ACABADO: Brillo

Soporte pared 45°.



F009

MATERIAL: Inoxidable AISI 304

ACABADO: Brillo

Soporte vidrio frontal tal. 12mm.

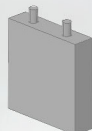

F010

MATERIAL: Inoxidable AISI 304

ACABADO: Brillo

Llave soporte F009.



Referencia	Descripción	Medidas	Cantidad
------------	-------------	---------	----------



F1	F001	Soporte vidrio	1 udad.
	F002	Soporte pared	1 udad.
	T14	Tubo 14mm	1000mm 1 udad.



F2	F001	Soporte vidrio	2 udes.
	F002	Soporte pared	2 udes.
	T14	Tubo 14mm	1000mm 2 udes.

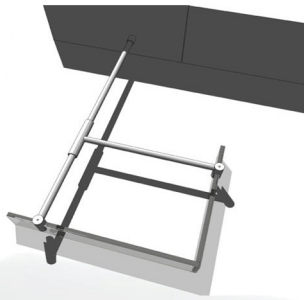

F3	F001	Soporte vidrio	2 udes.
	F002	Soporte pared	1 udad.
	F003	Soporte intersección	1 udad.
	T14	Tubo 14mm	2000mm 1 udad.



F4	F001	Soporte vidrio	2 udes.
	F002	Soporte pared	1 udad.
	F003	Soporte intersección	1 udad.
	F004	Soporte vidrio intersección	1 udad.
	T14	Tubo 14mm	2000mm 1 udad.



F5	F001	Soporte vidrio	1 udad.
	F005	Soporte vidrio a techo	1 udad.
	T14	Tubo 14mm	1000mm 1 udad.

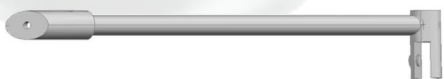

F6	F008	Soporte pared 45°	1 udad.
	F006	Soporte vidrio 45° izquierdo	1 udad.
	T14	Tubo 14mm	1000mm 1 udad.

Referencia	Descripción	Medidas	Cantidad
------------	-------------	---------	----------

F7



F008
F007
T14

Soporte pared 45°
Soporte vidrio 45° derecho
Tubo 14mm 1000mm

1 udad.
1 udad.
1 udad.

F8



F002
F009
T14

Soporte pared
Soporte vidrio frontal tal.12mm
Tubo 14mm 1000mm

1 udad.
1 udad.
1 udad.



